

Mesas con estilo nórdico. Ideales para aulas, recepciones, etc. Disponibles en dos colores diferentes. ¡Equipa tu espacio con nuestras mesas Sicilia!

ESPECIFICACIONES

•**Superficie:** Tablero de color blanco o arce de melamina de 19 mm de grosor acabado con cantos PVC de 2 mm y cantos redondeados.

•**Estructura:** Estructura metálica de color blanco acabada en pintura epoxi y con estructura metálica de refuerzo.

•**Patas:** Patas metálicas tubulares de 40 mm de diámetro con tapón y niveladores.

COLORES DISPONIBLES

Tablero

Blanco

Arce

Patas

Blanco

TALLAS DISPONIBLES

Talla 4, Talla 5 y Talla 6

FORMAS

Rectangular

Redonda

SUMINISTRO

Premontado

CAPACIDAD / MODELO

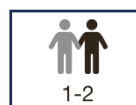

A

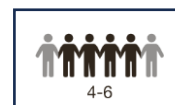

B



E



C



D

Certificados

















EN 1729-01: Dimensiones funcionales de mesas y sillas. Determina la talla apropiada para cada tamaño de niño.

EN 1729-02: Requisitos de seguridad de mesas y sillas. Examina la resistencia de mesas y sillas, así como los puntos de caída de las sillas con un peso determinado.

EN 438-2: Tableros de mesa. Análisis de la resistencia al impacto, manchado, abrasión calor y solidez de la luz.

EN 71-3: Migración de elementos. Análisis de la toxicidad de los elementos barnizados y/o pintados.

EN 14322: Tableros derivados de la madera. Tableros revestidos con melamina para utilización interior. Definición, requisitos y clasificación.

TABLA DE TALLAS *			
	ESTATURA (CM.)	EDAD	ALTURA MESA
EDUCACIÓN INFANTIL	T00	80 	1 año 
	T0	80-95 	2-3 años 
	T1	93-116 	3-4 años 
	T2	108-121 	4-6 años 
E. PRIMARIA	T3	119-142 	6-8 años 
	T4	133-159 	8-13 años 
E. SECUNDARIA	T5	146-176 	13-14 años 
	T6	159-188 	+14 años 

* Conforme Norma europea UNE EN 1729:2006
Edades orientativas

Medidas

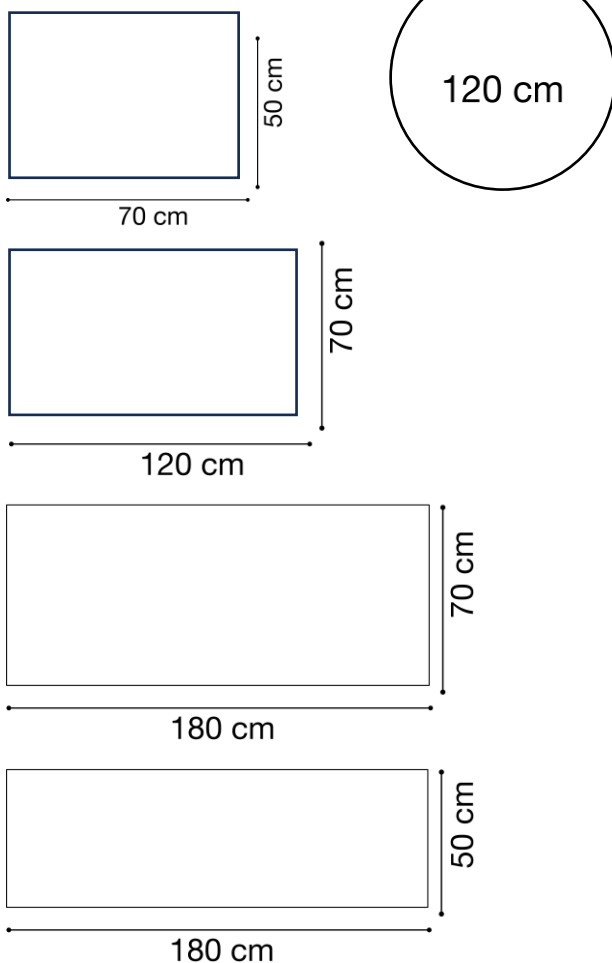

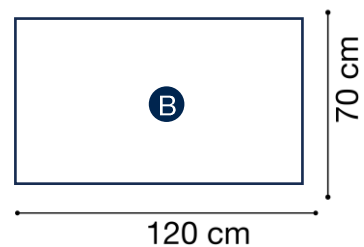
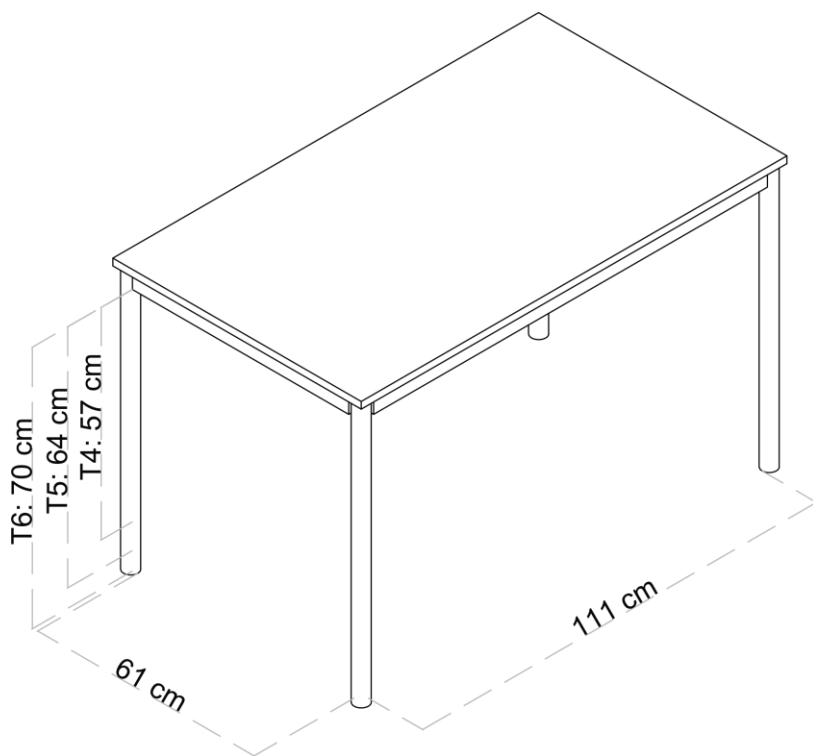
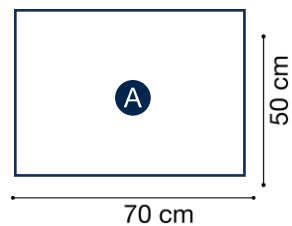
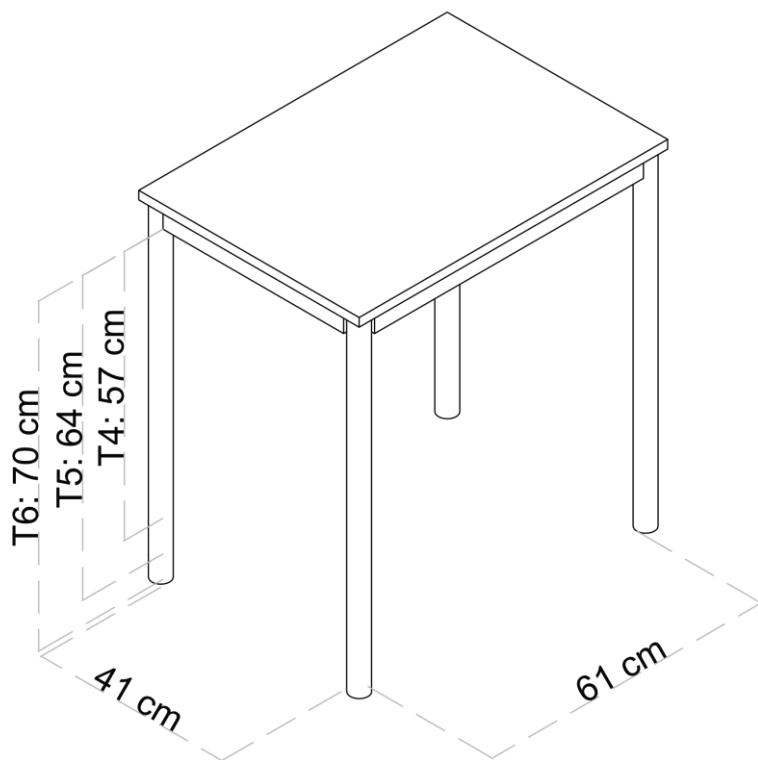

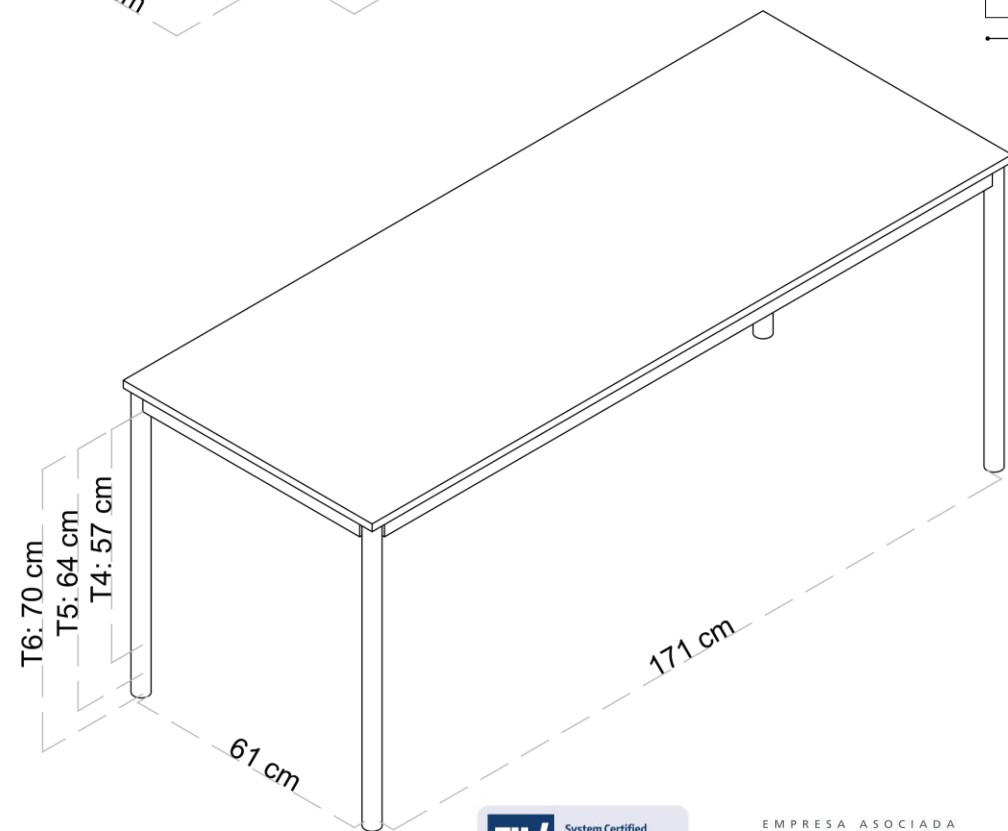
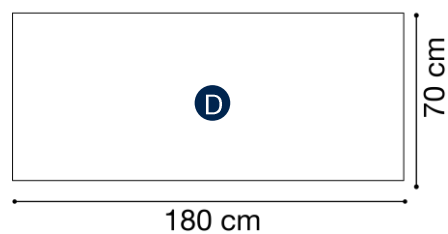
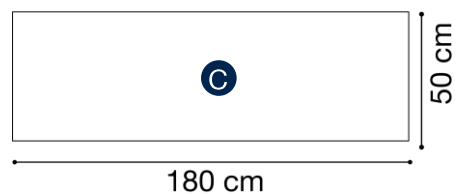
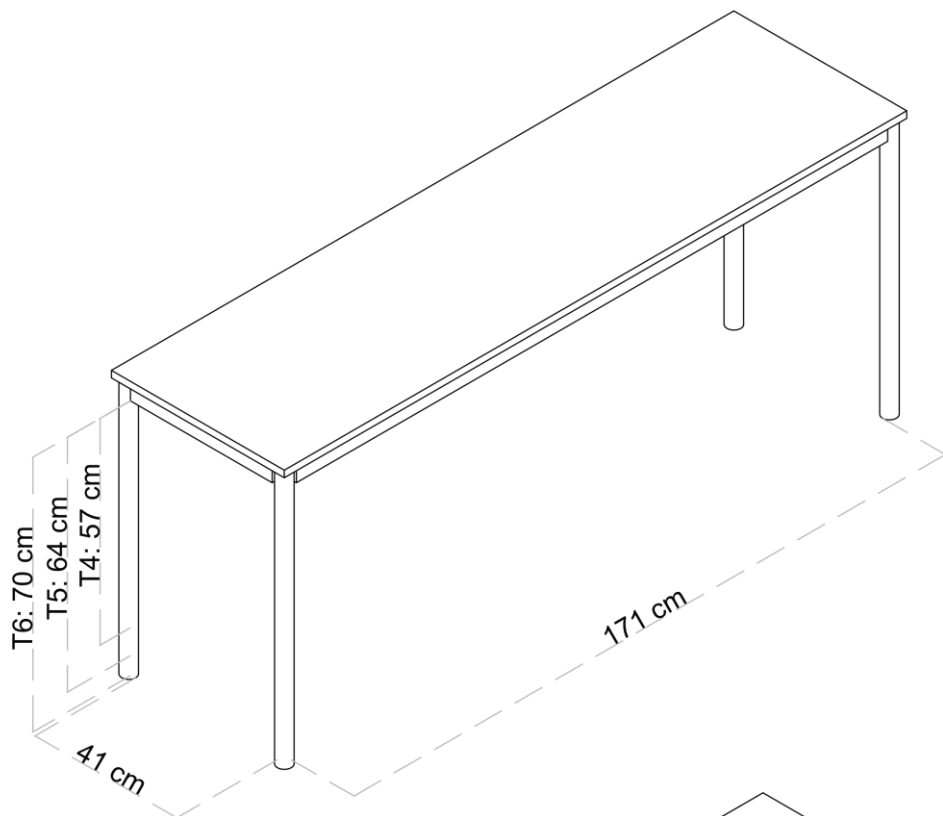

120 cm

E

