

Serie MOOVE2
Regulable con ruedas

**Memoria
técnica**

 **Hermex**
MOBILIARIO, EQUIPAMIENTO Y MATERIAL ESCOLAR
Todo un mundo para la Educación



¡Porque el mundo se mueve! La serie MOOVE2 cuenta con mesas regulables que se suben y bajan en un solo clic gracias a una palanca en el extremo de la mesa. Ideales para aulas polivalentes y espacios compartidos.

ESPECIFICACIONES

- **Tablero:** Tablero de melamina blanca de 19 mm de grosor y cantos de PVC de 2 mm.
- **Estructura:** Base metálica redonda y columna central que une el tablero de melamina blanca de 19 mm de grosor y cantos de PVC de 2 mm. Se acciona mediante palanca en un extremo de la mesa. Sistema de elevación mediante pistón de gas.
- **Patas:** Equipada con 4 ruedas con freno.

COLORES DISPONIBLES

Tablero y patas

Blanco

TALLAS DISPONIBLES

Regulable de 59 cm a 76 cm.

FORMA

Redonda

SUMINISTRO

Desmontado

CAPACIDAD



















4

FABRICADO SEGÚN LA NORMA:

EN 1729-01: Dimensiones funcionales de mesas y sillas. Determina la talla apropiada para cada tamaño de niño.

TABLA DE TALLAS *

		ESTATURA (CM.)		EDAD	ALTURA MESA
EDUCACIÓN INFANTIL	T00	80		1 año	 36 cm
	T0	80-95		2-3 años	 40 cm
	T1	93-116		3-4 años	 46 cm
	T2	108-121		4-6 años	 53 cm
E. PRIMARIA	T3	119-142		6-8 años	 59 cm
	T4	133-159		8-13 años	 64 cm
E. SECUNDARIA	T5	146-176		13-14 años	 71 cm
	T6	159-188		+14 años	 76 cm

* Conforme Norma europea UNE EN 1729:2006
Edades orientativas

Medidas

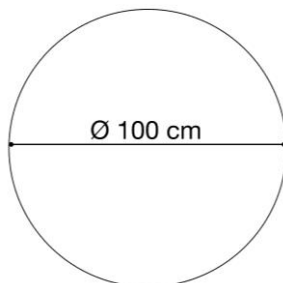

Serie MOOVE2
Espacio de luz

Memoria
técnica

 **Hermex**
MOBILIARIO, EQUIPAMIENTO Y MATERIAL ESCOLAR
Todo un mundo para la Educación

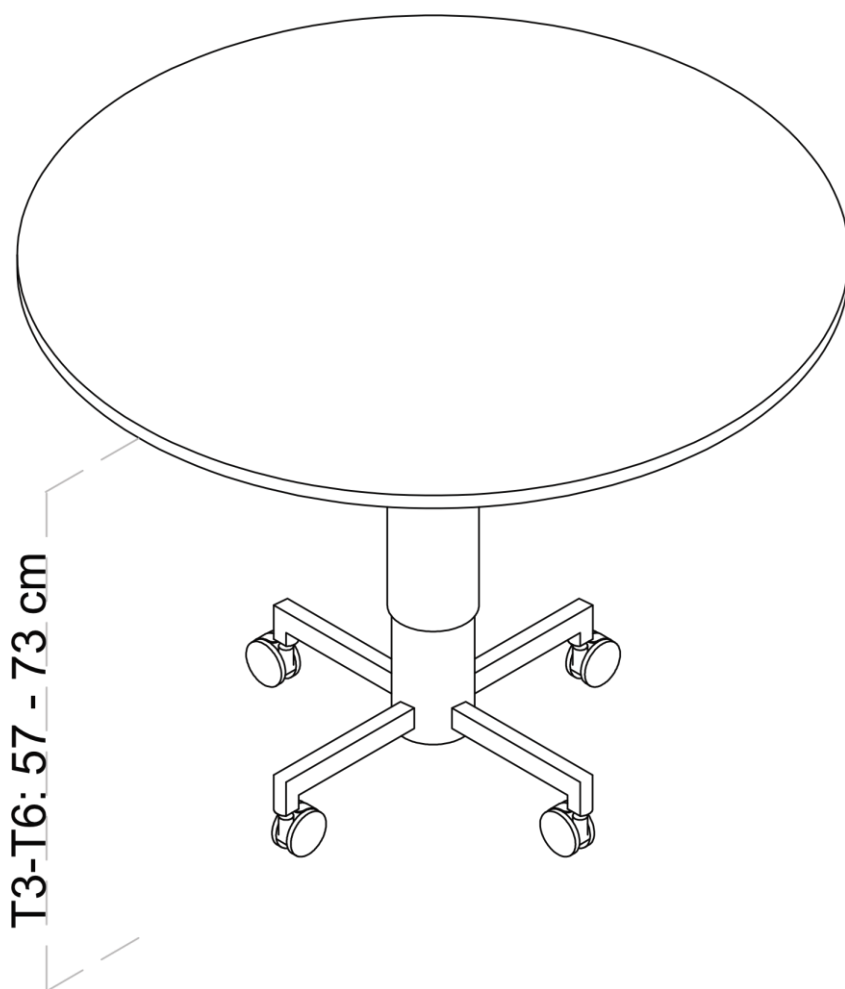
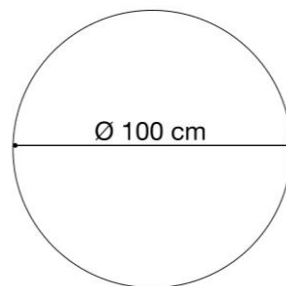

EMPRESA ASOCIADA
 **AIDIMME**®
INSTITUTO TECNOLÓGICO
METALMECÁNICO, MUEBLES, MAQUINA, EMBALAJE Y AFINES